

Squadretta in ferro per tende

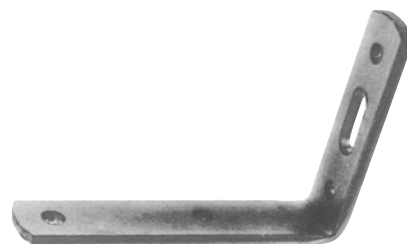

ART.	Dimensioni mm	Sfuso	LINEA SELF SERVICE						
		51 	10. SCATOLETTA PZ		61. FASCETTA PZ		PZ		
3013	100 x 70	48							
3014	120 x 70	48							
3015	150 x 70	48							



Finiture disponibili: 98 Zincato

Piastrina diritta in ferro

ART.	Dimensioni mm	Sfuso	LINEA SELF SERVICE						
		51 	10. SCATOLETTA PZ		61. FASCETTA PZ		PZ		
9001	120 x 15	200	--	--	4	24			
9002	100 x 15	200	3	12	4	24			
9003	80 x 15	200	4	12	4	24			
9004	60 x 15	200	4	12	4	24			
9034	40 x 15	200	5	12	4	24			



Finiture disponibili: 97 Tropical - 98 Zincato

Piastrina in ferro

ART.	Dimensioni mm	Sfuso	LINEA SELF SERVICE						
		51 	10. SCATOLETTA PZ		61. FASCETTA PZ		PZ		
9037	70 x 35	200	4	12	4	24			
9027	50 x 40	200	4	12	4	24			
9038	40 x 35	200	4	12	4	24			

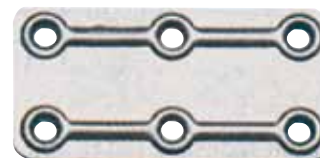

Finiture disponibili: 98 Zincato

Angolo in ferro

ART.	Dimensioni mm	Sfuso	LINEA SELF SERVICE						
		51 	10. SCATOLETTA PZ		61. FASCETTA PZ		PZ		
4203	160 x 160	50	--	--	4	24			
4202	120 x 120	50	--	--	4	24			
9036	100 x 100	100	--	--	4	24			
9035	80 x 80	100	--	--	4	24			
9005	60 x 60	200	3	12	4	24			
9006	50 x 50	200	3	12	4	24			
9007	40 x 40	200	4	12	4	24			
9008	30 x 30	200	4	12	4	24			

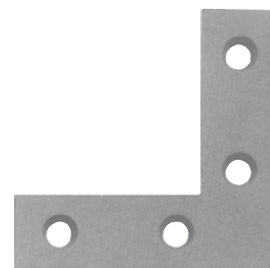

Finiture disponibili: 98 Zincato **IMPORTANTE:** le 4 misure più piccole anche finitura 97 Tropical

ART.	Dimensioni mm	Sfuso	LINEA SELF SERVICE					
		51 	10 SCATOLETTA 		61 FASCETTA 			
9022	60 x 20	200	4	12	4	24		
9023	80 x 20	200	4	12	4	24		
9024	100 x 20	200	4	12	4	24		

Finiture disponibili: 98 Zincato



Attaccaglia in ferro

ART.	Dimensioni mm	Sfuso	LINEA SELF SERVICE					
		51 	08 BIVALVA 					
3012	100 x 20	100	2	12				

Finiture disponibili: 98 Zincato



Fermacompensati

ART.	Dimensioni mm	Sfuso	LINEA SELF SERVICE					
		51 	10 SCATOLETTA 					
9026	20 x 17	1000	15	12				

Finiture disponibili: 98 Zincato



Squadretta in ottone



ART.	Dimensioni mm	Sfuso	LINEA SELF SERVICE					
		51 	10 SCATOLETTA					
			PZ		PZ		PZ	
9689	60 x 60 x 12	100	4	12				
9690	50 x 50 x 12	100	4	12				
9691	40 x 40 x 10	100	4	12				
9692	30 x 30 x 10	100	4	12				



Finiture disponibili: 03 Ottone lucido

Piastrina dritta in ottone

ART.	Dimensioni mm	Sfuso	LINEA SELF SERVICE					
		51 	10 SCATOLETTA					
			PZ		PZ		PZ	
9682	100 x 12	100	4	12				
9683	80 x 12	100	4	12				
9684	60 x 12	100	4	12				



Finiture disponibili: 03 Ottone lucido

Angolo in ottone

ART.	Dimensioni mm	Sfuso	LINEA SELF SERVICE					
		51 	10 SCATOLETTA					
			PZ		PZ		PZ	
9685	60 x 60	100	4	12				
9686	45 x 45	100	4	12				
9688	30 x 30	100	4	12				









Finiture disponibili: 03 Ottone lucido

Squadretta LUX

ART.	Dimensioni mm	Sfuso	LINEA SELF SERVICE					
		51 	10 SCATOLETTA		61 FASCETTA			
			PZ		PZ		PZ	
9059	60 x 60 x 15	200	4	12	4	24		
9060	50 x 50 x 15	200	4	12	4	24		
9061	40 x 40 x 15	200	4	12	4	24		
9062	30 x 30 x 15	200	4	12	4	24		



Finiture disponibili: 02 Bronzato - 60 Nero - 61 Bianco

ART.	Dimensioni mm	Sfuso	LINEA SELF SERVICE					
		51	05 SKINPACK		10 SCATOLETTA		61 FASCETTA	
			PZ 		PZ 		PZ 	
9051	120 x 15	200	4	12	--	--	4	24
9052	100 x 15	200	--	--	4	12	4	24
9053	80 x 15	200	--	--	4	12	4	24
9054	60 x 15	200	--	--	4	12	4	24



Finiture disponibili: 02 Bronzato - 60 Nero - 61 Bianco

Angolo in acciaio per esterni



ART.	Dimensioni mm				Sfuso	LINEA SELF SERVICE					
	A	B	C	Spessore		PZ		PZ		PZ	
9851	60	60	40	2	51						
9853	60	60	60	2	50						
9855	80	80	60	2	25						
9856	80	80	80	2	25						
9858	100	100	80	2	25						
9859	100	100	100	2	25						

Finiture disponibili: 97 Tropical

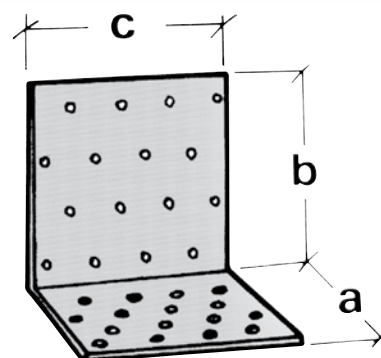

Angolo in acciaio per esterni

ART.	Dimensioni mm				Sfuso	LINEA SELF SERVICE					
	A	B	C	Spessore		PZ		PZ		PZ	
9861	50	50	40	2	100						
9862	90	90	40	2	50						

Finiture disponibili: 97 Tropical

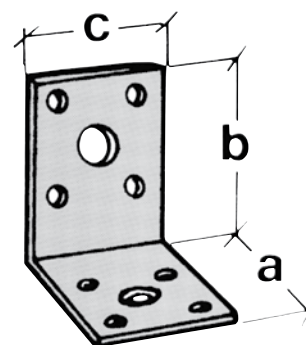

Angolo in acciaio per esterni

ART.	Dimensioni mm				Sfuso	LINEA SELF SERVICE					
	A	B	C	Spessore		PZ		PZ		PZ	
9863	35	90	40	2	100						
9864	35	130	40	2	50						
9865	35	170	40	2	50						

Finiture disponibili: 97 Tropical

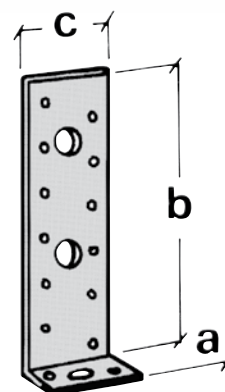

Angolo in acciaio per esterni

ART.	Dimensioni mm				Sfuso	LINEA SELF SERVICE					
	A	B	C	Spessore		PZ		PZ		PZ	
9866	50	50	40	2	100						
9867	90	90	40	2	50						

Finiture disponibili: 97 Tropical

