

Binario per pensili



ART.	Dimensioni mm	Sfuso	LINEA SELF SERVICE							
		51 	PZ		PZ		PZ			
9043	2000	10								



Finiture disponibili: 98 Zincato

Supporto per pensili

ART.	Dimensioni mm	Tipo	Sfuso	LINEA SELF SERVICE						
			51 	08 RIVALVA PZ		PZ		PZ		
9042.51	50 x 30	DX	50	1 DX	12					
9042.52	50 x 30	SX	50	1 SX						



Finiture disponibili: 61 Bianco - 67 Marrone

Supporto per pensili

ART.	Dimensioni mm	Sfuso	LINEA SELF SERVICE							
		51 	03 SACCHETTO PZ		08 RIVALVA PZ		PZ			
9041	46 x 56	50	2	12	2	12				



Finiture disponibili: 98 Zincato

Supporto per pensili

ART.	Dimensioni mm	Sfuso	LINEA SELF SERVICE							
		51 	03 SACCHETTO PZ		08 RIVALVA PZ		PZ			
9025	45 x 50	50	2	12	2	12				



Finiture disponibili: 98 Zincato

Carrellino per vetri scorrevoli



ART.	Dimensioni mm	Sfuso	LINEA SELF SERVICE					
		51 	08 BIVALVA					
0507	35	100 	PZ		PZ		PZ	

Finiture disponibili: 00 Nickelato



Carrellino per vetri scorrevoli

ART.	Dimensioni mm	Sfuso	LINEA SELF SERVICE					
		51 	08 BIVALVA					
0505	45	100 	PZ		PZ		PZ	

Finiture disponibili: 00 Nickelato

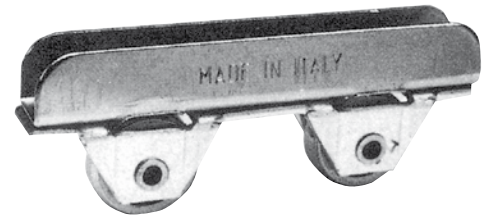

Carrellino per vetri scorrevoli

ART.	Dimensioni mm	Sfuso	LINEA SELF SERVICE					
		51 	08 BIVALVA					
0503	35	100 	PZ		PZ		PZ	

Finiture disponibili: 00 Nickelato

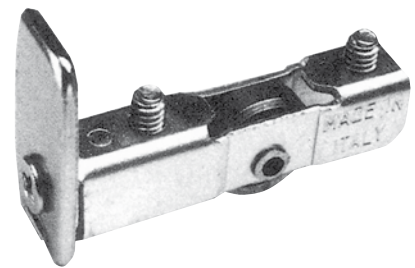

Binario per vetri scorrevoli

ART.	Dimensioni mm	Sfuso	LINEA SELF SERVICE					
		51 	08 BIVALVA					
0530	2000	12 	PZ		PZ		PZ	

Finiture disponibili: 99 Alluminio naturale

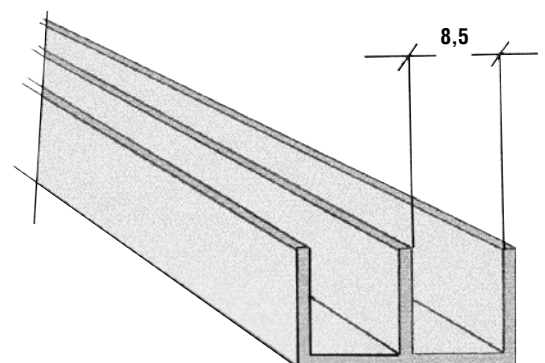

MOD. A

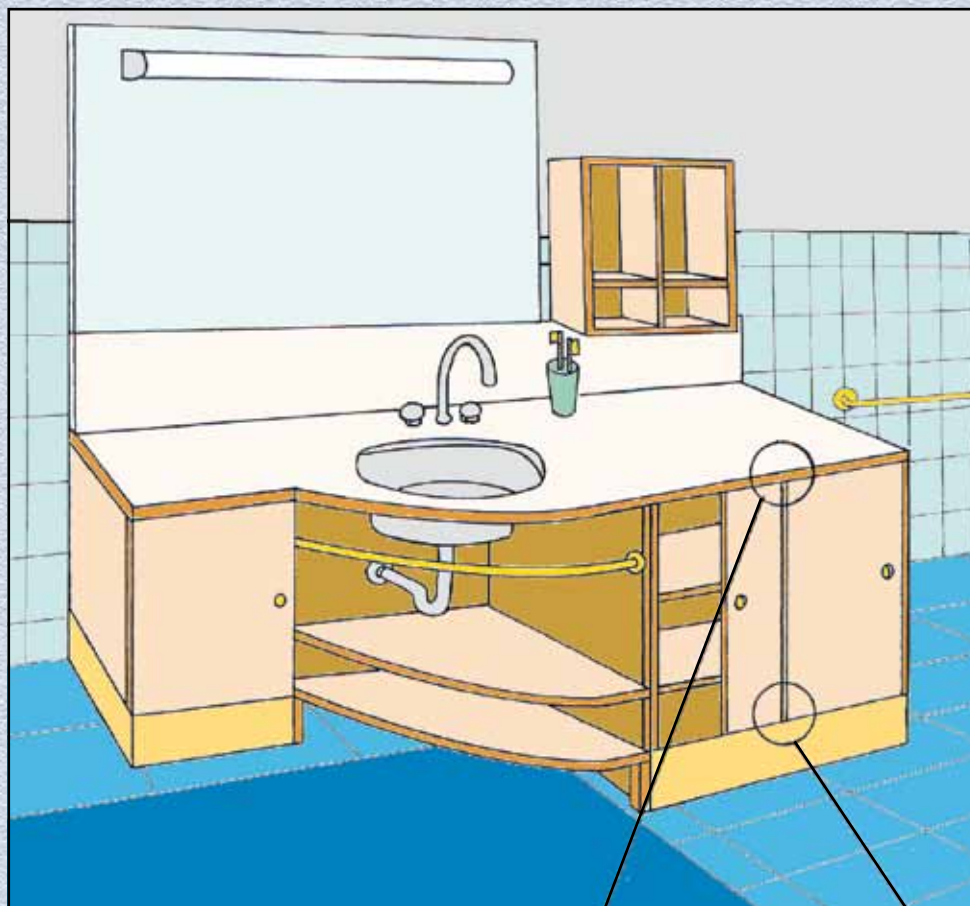

DIMENSIONI DELLE ANTE:
 Peso massimo kg 15
 Spessore minimo mm 20
 Larghezza massima cm 75

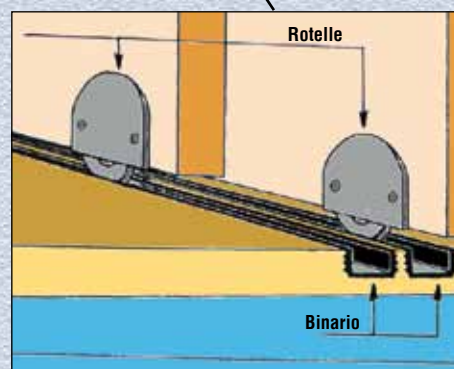
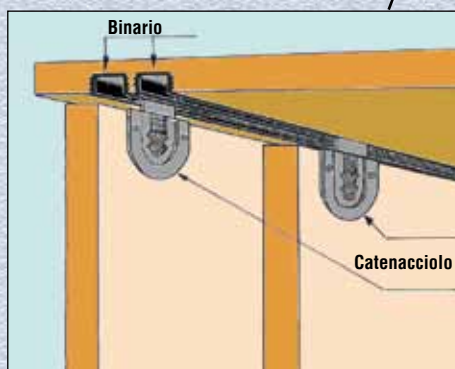

FERRAMENTA

ART.	Contenuto	Sfuso	LINEA SELF SERVICE		
		51	07 BLISTER		
0574	4 rotelle - 4 catenaccioli	10	1	10	

Finiture disponibili: 60 Plastica nero

BINARIO

ART.	Lunghezza mm	Sfuso
0573	1500	20

Finiture disponibili: 60 Plastica nero

MOD. B

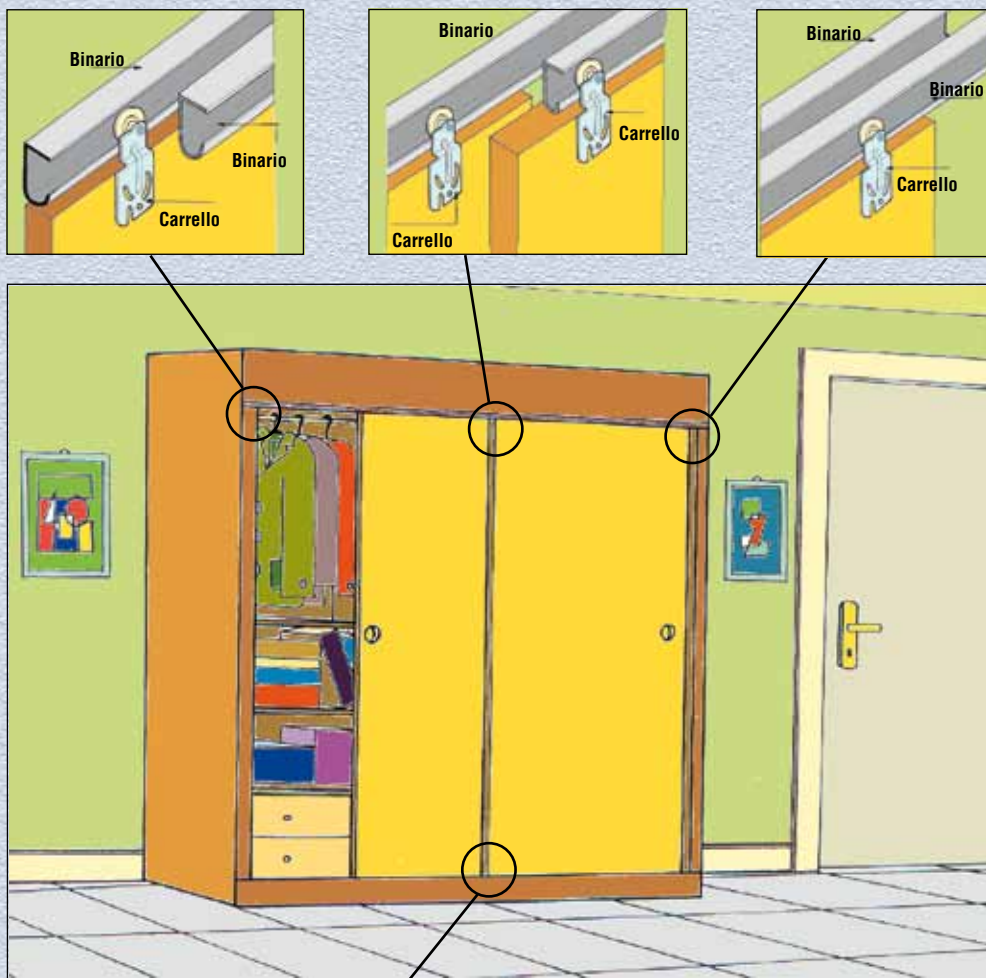

DIMENSIONI DELLE ANTE:
 Peso massimo kg 40
 Spessore mm 19 - 25 - 30 - 35
 Larghezza massima cm 100

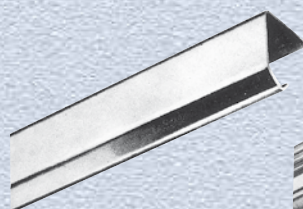

Art. 1834
Binario Singolo

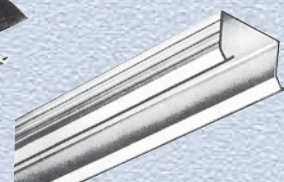

Art. 1749
Binario Doppio

FERRAMENTA

ART.	Contenuto	Sfuso	LINEA SELF SERVICE					
		51	07 BUSTER					
0551	4 carrelli - 1 guida	10	1	10				

Finiture disponibili: 98 Zincato

BINARI

ART.	Lunghezza mm	Sfuso
		20
1834	2000	10
1749	2000	10

Finiture disponibili: 99 Alluminio grezzo

MOD. C

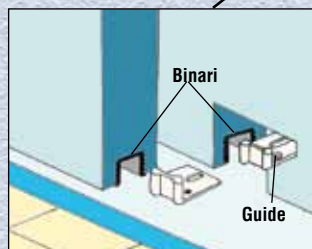
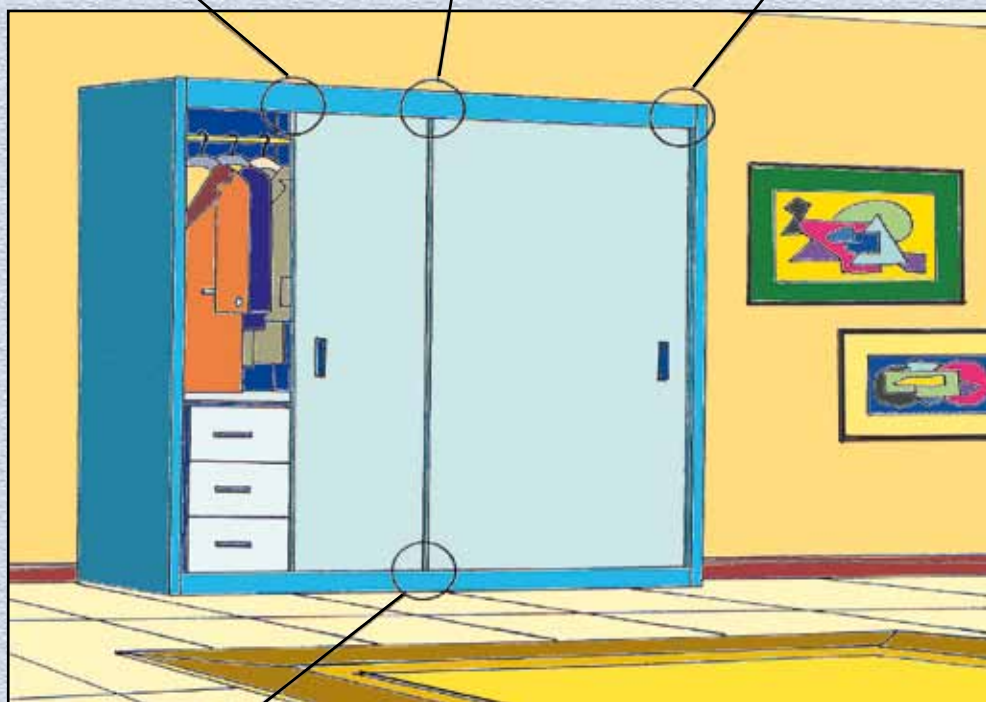
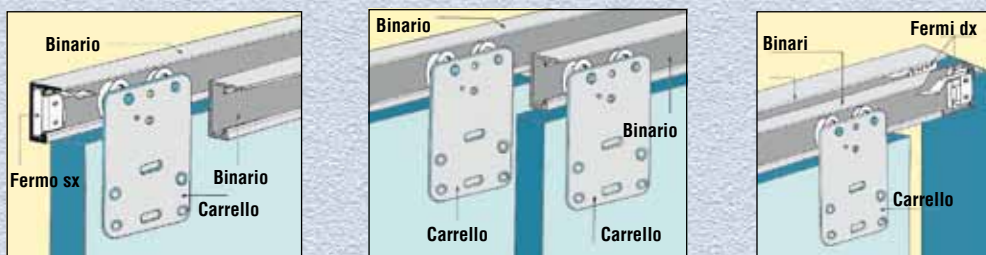

DIMENSIONI DELLE ANTE:
 Peso massimo kg 80 (con Art. 0557)
 Peso massimo kg 50 (con Art. 0556)
 Spessore minimo mm 20
 Larghezza massima cm 100

FERRAMENTA

ART.	Contenuto	Sfuso 51 	LINEA SELF SERVICE			
			07 BILISTER PZ	PZ	PZ	
0557	2 carrelli per kg 80 2 freni (dx-sx) 1 guida - 4 viti antigancio 8 viti con bussole	5	1	5		
0556	2 carrelli per kg 50 2 freni (dx-sx) 1 guida - 4 viti antigancio 8 viti con bussole	5	1	5		

Finiture disponibili: 98 Zincato

BINARI

ART.	Lunghezza mm	Sfuso 51
0540	2000 Binario Superiore	5
0563	2000 Binario Inferiore	20

Finiture disponibili: 99 Alluminio grezzo

Finiture disponibili: 60 Plastica nero

MOD. F

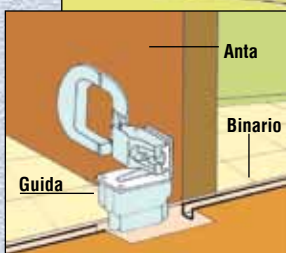
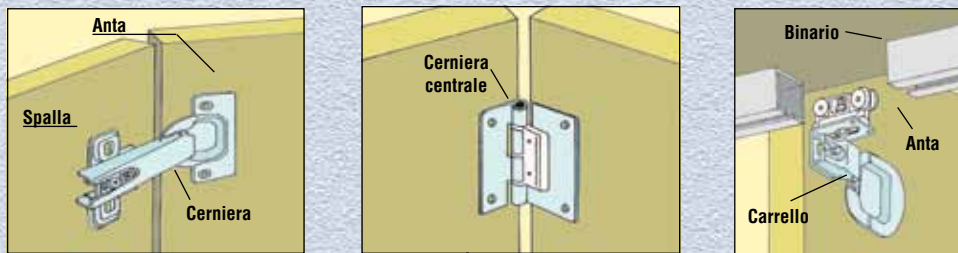

DIMENSIONI DELLE ANTE:
 Peso massimo kg 50
 Spessore minimo mm 20
 Larghezza massima cm 100

FERRAMENTA

ART.	Contenuto	Sfuso	LINEA SELF SERVICE					
		51	07.BLISTER					
			PZ		PZ		PZ	
0571	1 carrello con cerniera 1 guida con cerniera 2 cerniere 110° 3 cerniere centrali	5	1	5				

Finiture disponibili: 98 Zincato

BINARI

ART.	Lunghezza mm	Sfuso
		51
0572	2000 Binario Superiore	5
0563	2000 Binario Inferiore	20

Finiture disponibili: 99 Alluminio grezzo

Finiture disponibili: 60 Plastica nero

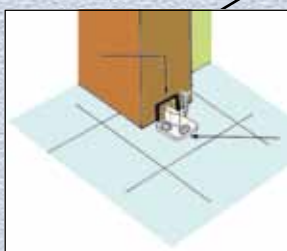
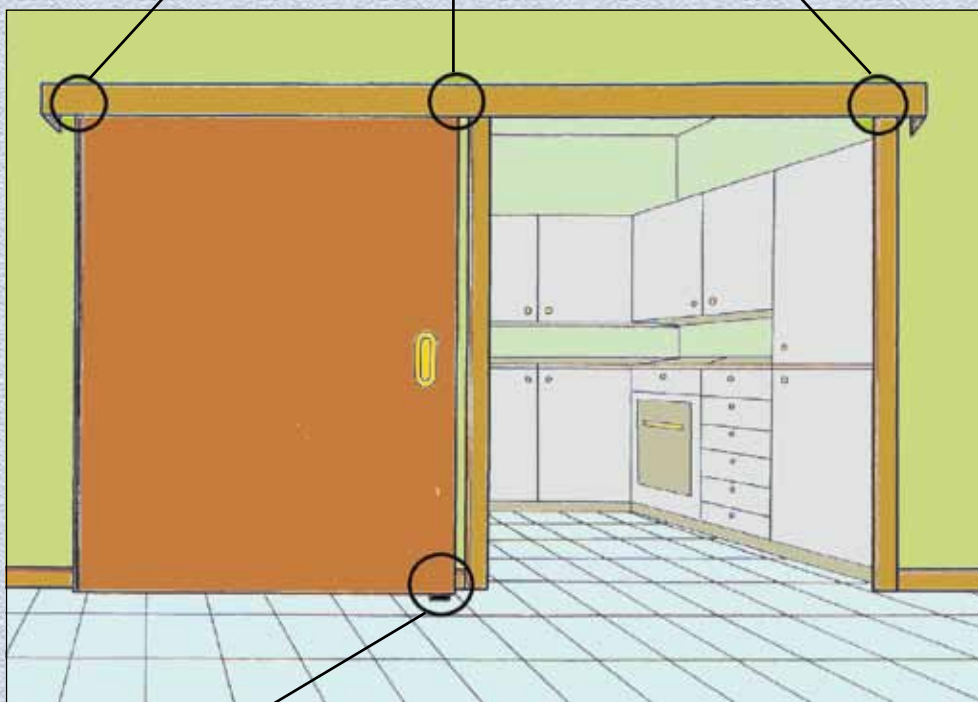

DIMENSIONI DELLA PORTA:
 Peso massimo kg 150 (con Art. 0555)
 Peso massimo kg 80 (con Art. 0554)
 Spessore minimo mm 30
 Larghezza da min cm 50 a max cm 120

FERRAMENTA

ART.	Contenuto	Sfuso	LINEA SELF SERVICE					
		51 	07. BLISTER					
			PZ		PZ		PZ	
0555	2 carrelli per kg 150 2 freni 1 guida 4 serie squadrette	5	1	5				
0554	2 carrelli per kg 80 2 freni 1 guida 4 serie squadrette	5	1	5				

Finiture disponibili: 98 Zincato

BINARI

ART.	Lunghezza mm	Sfuso
		51
0538	2000 Binario Superiore	5
0563	2000 Binario Inferiore	20

Finiture disponibili: 99 Alluminio grezzo

Finiture disponibili: 60 Plastica nero